

Product Feature

1. Package Type: 1"X 1"
2. Input voltage range: 2:1
3. Operating temperature range: -40°C - +85°C
4. Isolation voltage: 1500VDC
5. Equipped with output short-circuit protection and overcurrent protection mec
6. Fields of application: Industry, power, instrumentation, communication, rail transit.

3 years Warranty

Selection Guide

Part No.	Input Voltage (VDC)		Output		Full Load Efficiency% (Typ.)	Capacitive Load(μF) Max.
	Nominal (Range)	Max.	Voltage (VDC)	Current(mA) Max./Min.		
GTA1205YMD-6WR3	12 (9-18)	20	±5	±600/0	79/81	#470
GTA1212YMD-6WR3			±12	±250/0	83/85	#100
GTA1215YMD-6WR3			±15	±200/0	81/83	#100
GTB1205YMD-6WR3			5	1200/0	79/81	1000
GTB1212YMD-6WR3			12	500/0	83/85	470
GTB1224YMD-6WR3			24	250/0	83/85	100
GTA2405YMD-6WR3	24 (18-36)	40	±5	±600/0	81/83	#470
GTA2412YMD-6WR3			±12	±250/0	85/87	#100
GTA2415YMD-6WR3			±15	±200/0	85/87	#100
GTB2403YMD-6WR3			3.3	1500/0	75/77	1800
GTB2405YMD-6WR3			5	1200/0	80/82	1000
GTB2409YMD-6WR3			9	667/0	83/85	470
GTB2412YMD-6WR3			12	500/0	83/85	470
GTB2415YMD-6WR3			15	400/0	84/86	220
GTB2424YMD-6WR3			24	250/0	83/85	100
GTB4803YMD-6WR3			48 (36-75)	80	3.3	1500/0
GTB4805YMD-6WR3	5	1200/0			81/83	1000
GTB4812YMD-6WR3	12	500/0			85/87	470
GTB4815YMD-6WR3	15	400/0			86/88	220
GTB4824YMD-6WR3	24	250/0			86/88	100

Input Specifications

Item	Operating Conditions	Min.	Typ.	Max.	Unit	
Input Current (full load/no-load)	12VDC nominal input series	--	603/10	633/22	mA	
	24VDC nominal input series	3.3VDC Output	--	268/5		275/15
		Other Output	--	296/5		313/15
	48VDC nominal input series	3.3VDC Output	--	130/4		134/8
Other Output		--	150/4	155/8		
Reflected Ripple Current		--	20	--	mA	
	12VDC nominal input series	-0.7	--	25		

Impulse Voltage	24VDC nominal input series	-0.7	--	50	VDC
	48VDC nominal input series	-0.7	--	100	
Starting Voltage	12VDC nominal input series	--	--	9	
	24VDC nominal input series	--	--	18	
	48VDC nominal input series	--	--	136	
Input undervoltage protection	12VDC nominal input series	5.5	6.5	--	
	24VDC nominal input series	12	15.5	--	
	48VDC nominal input series	26	30	--	
Input Filter		PI filter			
Hot Plug		Unavailable			

Output Specifications

Item	Operating Conditions	Min.	Typ.	Max.	Unit
Voltage Accuracy	0%- 100% load	--	±1	±3	%
Linear Regulation	Input voltage variation from low to high at full load	Vo1	--	±0.2	±0.5
		Vo2	--	±0.5	±1
Load Regulation	5%- 100% load	Vo1	--	±0.5	±1
		Vo2	--	±0.5	±1.5
Ripple & Noise	20MHz bandwidth, 5%- 100% load	--	60	85	mVp-p
Transient Recovery Time	25% load step change, nominal input voltage	--	300	500	µs
Transient Response Deviation	25% load step change, nominal input voltage	--	±3	±5	%
Temperature Coefficient	Full load	--	--	±0.03	%/°C
Over-voltage Protection	Input voltage range	110	--	160	%Vo
Over-current Protection	Input voltage range	110	140	190	%Io
Short-circuit Protection	Input voltage range	Continuous, self-recovery			

General Specifications

Item	Operating Conditions	Min.	Typ.	Max.	Unit
Isolation	Input-output Electric Strength Test for 1 minute with a leakage current of 1mA max.	1500	--	--	VDC
Insulation Resistance	Input-output resistance at 500VDC	1000	--	--	MΩ
Isolation Capacitance	Input-output capacitance at 100kHz/0. 1V	--	1000	--	pF
Operating Temperature	See Fig.1	-40	--	+85	°C
Storage Temperature		-55	--	+125	°C
Storage Humidity		5	--	95	%RH
Pin Soldering Resistance Temperature	Soldering spot is 1.5mm away from case for 10 seconds	--	--	+300	°C
Switching Frequency		--	312.5	--	kHz
MTBF	MIL-HDBK-217F@25°C	1000			k hours

Mechanical Specifications

Case Material	Aluminum alloy
Package Dimensions	25.4 X 25.40 X 12.00 mm
Weight	11.60g(Typ.)
Cooling Method	Free air convection

EMC Specifications

EMI	CE	CISPR32/EN55032 CLASSA(Open flame) /CLASS B (see Fig.3-② for recommended circuit)				
	RE	CISPR32/EN55032 CLASSA(Open flame) /CLASS B (see Fig.3-② for recommended circuit)				
EMS	ESD	IEC/EN61000-4-2	Contact±4KV	perf.	Criteria	B
	RS	IEC/EN61000-4-3	10V/m	perf.	Criteria	A
	EFT	IEC/EN61000-4-4	±2kV(see Fig.3-①for recommended circuit)	perf.	Criteria	B
	Surge	IEC/EN61000-4-5	line to line±2KV (see Fig.3-①for recommended circuit)	perf.	Criteria	B
	CS	IEC/EN61000-4-6	3Vr.m.s	perf.	Criteria	A

Typical Characteristic Curves

Temperature Derating Curve (Figure 1)

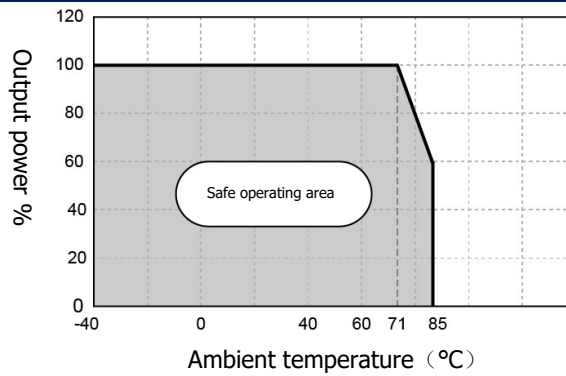

Efficiency Vs Input Voltage (Full Load)

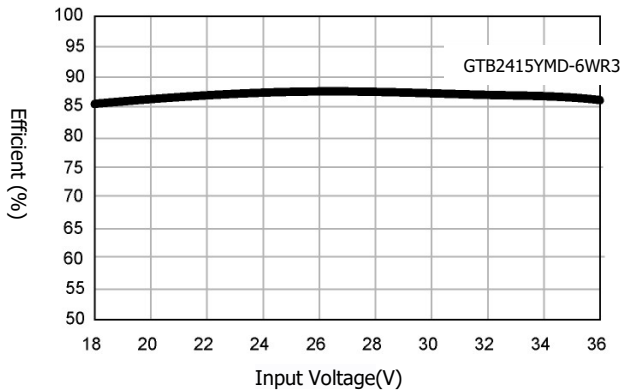

Efficiency Vs Output Voltage (Vin=24V)

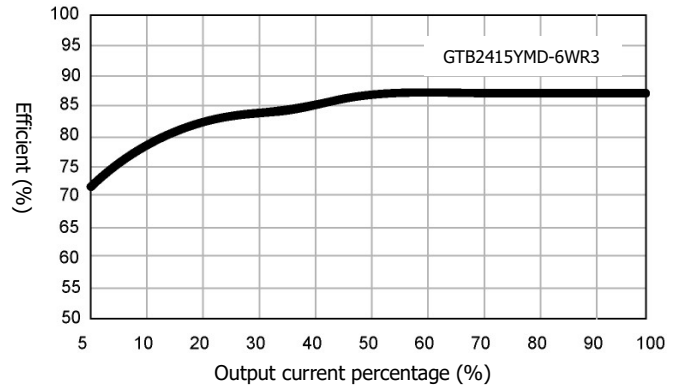

Efficiency Vs Input Voltage (Full Load)

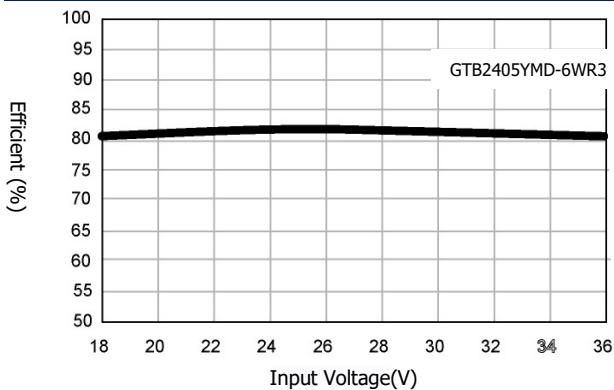

Efficiency Vs Output Voltage (Vin=24V)

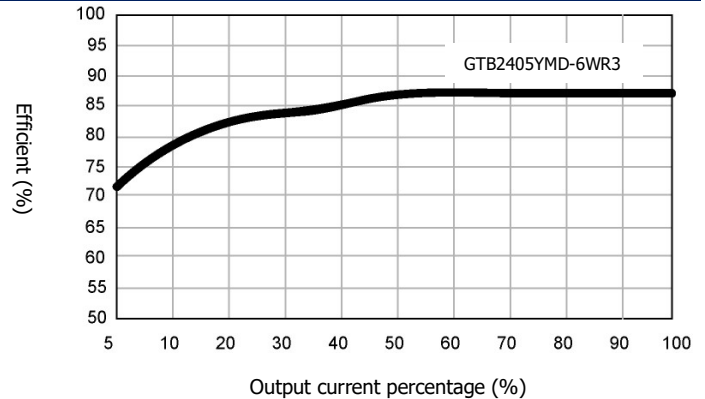

Typical Circuit Design And Application

Figure 2	Recommended component parameters			
	Vin	12V	24V	48V
	Cin	100uF	10-47uF	100uF
	Cout	10uF		

EMC compliance circuit Figure 3

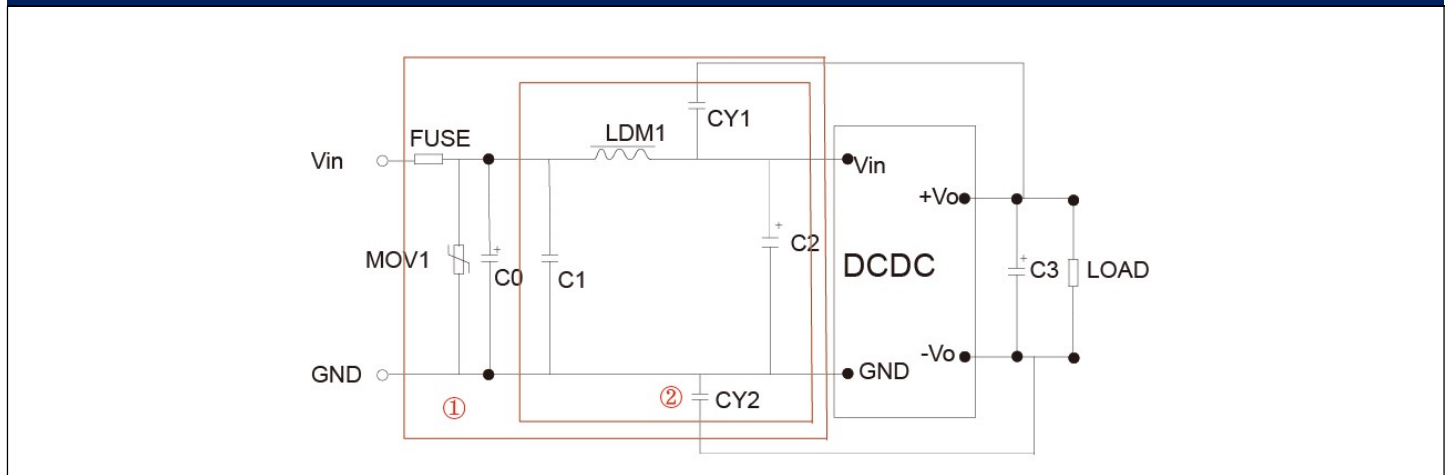

EMI Recommended component parameters

Vin	12V	24V	48V
FUSE	Choose according to actual input current		
MOV	14D330K	20D470K	14D101K
C0	1000uF/50V	1000uF/50V	680uF/100V
C1	1uF/50V	1uF/50V	4.7uF/100V
C2	330uF/50V	330uF/50V	330uF/100V
C3	Refer to the Cout in Fig.2		
LCM	4.7uH		
CY1、CY2	1nF/2KV		

Note:

- All DC-DC converters of this series are tested before delivery using the recommended circuit shown in Fig.2.
- Input and/or output ripple can be further reduced by appropriately increasing the input & output capacitor values Cin and Cout and/or by selecting capacitors with a low ESR (equivalent series resistance). Also make sure that the capacitance is not exceeding the specified max. capacitive load value of the product.
- The products do not support parallel connection of their output.

Dimensions and Recommended Layout

Dimensions

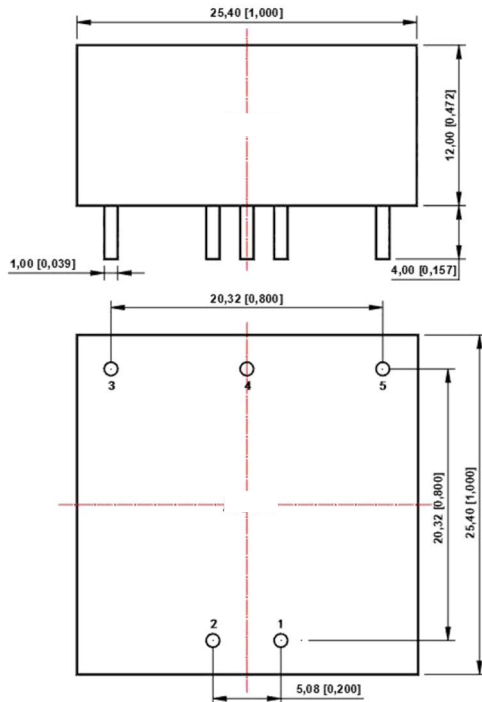

PCB Printing Layout

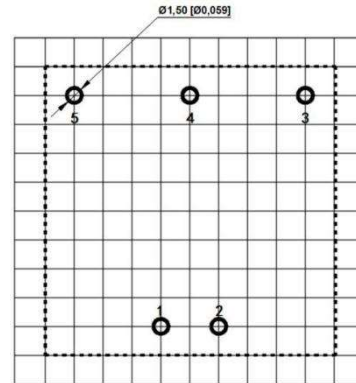

The grid distance is 2.54 x 2.54mm

Pin Definition Table

Pin	Single	Dual
1	GND	GND
2	Vin	Vin
3	+Vo	+Vo
4	No Pin	COM
5	-Vo	-Vo

Note:

- Unit: mm[inch]
- Pin section tolerances: $\pm 0.10[\pm 0.004]$
- General tolerances: $\pm 0.50[\pm 0.020]$

Note:

1. The input voltage should not exceed the specified range value, otherwise it may cause permanent and irreparable damage;
2. It is recommended to use at a load of over 5%. If the load is below 5%, the ripple index of the product may exceed the specifications, but it does not affect the reliability of the product;
3. Suggested dual output module load imbalance: $\leq \pm 5\%$. If it exceeds $\pm 5\%$, it cannot be guaranteed that the product performance meets all performance indicators in this manual;
4. The maximum capacitive load is tested within the input voltage range and under full load conditions;
5. Unless otherwise specified, all indicators in this manual are measured at $T_a=25\text{ }^\circ\text{C}$, humidity $<75\%$ RH, nominal input voltage, and output rated load;
6. All indicator testing methods in this manual are based on our company's corporate standards;
7. Our company can provide product customization, and specific requirements can be directly contacted by our technical personnel;
8. Product specifications are subject to change without prior notice.