

Product Feature

1. Package Type: 1"X 1"
2. Input voltage range: 4:1
3. Operating temperature range: -40°C - +85°C
4. Isolation voltage: 1500VDC
5. High efficiency up : 88% (Typ.)
6. Equipped with output short-circuit protection and overcurrent protection mechanisms
7. Fields of application: Industry, power, instrumentation, communication, rail transit.

**3 years
Warranty**

Selection Guide

Part No.	Input Voltage (VDC)		Output		Full Load Efficiency% (Typ.)	Capacitive Load(μF) Max.
	Nominal (Range)	Max.	Voltage (VDC)	Current(mA) Max./Min.		
ATB2403YMD-6WR3	24 (9-36)	40	3.3	1500/0	79	1800
ATB2405YMD-6WR3	24 (9-36)	40	5	1200/0	83	1000
ATB2409YMD-6WR3	24 (9-36)	40	9	667/0	85	680
ATB2412YMD-6WR3	24 (9-36)	40	12	500/0	87	470
ATB2415YMD-6WR3	24 (9-36)	40	15	400/0	87	220
ATB2424YMD-6WR3	24 (9-36)	40	24	250/0	88	100
ATA2405YMD-6WR3	24 (9-36)	40	±5	±600/0	83	#470
ATA2412YMD-6WR3	24 (9-36)	40	±12	±250/0	87	#100
ATA2415YMD-6WR3	24 (9-36)	40	±15	±200/0	87	#100
ATA2424YMD-6WR3	24 (9-36)	40	±24	±125/0	87	#100
ATB4803YMD-6WR3	48 (18-75)	80	3.3	1500/0	79	1800
ATB4805YMD-6WR3	48 (18-75)	80	5	1200/0	83	1000
ATB4812YMD-6WR3	48 (18-75)	80	12	500/0	87	470
ATB4815YMD-6WR3	48 (18-75)	80	15	400/0	88	220
ATB4824YMD-6WR3	48 (18-75)	80	24	250/0	88	100
ATA4805YMD-6WR3	48 (18-75)	80	±5	±600/0	83	#470
ATA4812YMD-6WR3	48 (18-75)	80	±12	±250/0	87	#100
ATA4815YMD-6WR3	48 (18-75)	80	±15	±200/0	88	#100

Input Specifications

Item	Operating Conditions		Min.	Typ.	Max.	Unit
Input Current (full load/no-load)	24VDCnominal input series	3.3VDC Output	--	261/5	--	mA
		Other Output	--	292/5	--	
	48VDCnominal input series	3.3VDC Output	--	130/4	--	
		Other Output	--	146/4	--	
Reflected Ripple Current	24VDCnominal input series		--	20	--	mA
Impulse Voltage	24VDCnominal input series		-0.7	--	50	
	48VDCnominal input series		-0.7	--	100	
	24VDCnominal input series		--	--	9	

Starting Voltage	48VDCnominal input series	--	--	18	VDC
Input undervoltage protection	24VDCnominal input series	5.5	6.5	--	
	48VDCnominal input series	12	15.5	--	
Input Filter	PI filter				
Hot Plug	Unavailable				

Output Specifications

Item	Operating Conditions	Min.	Typ.	Max.	Unit	
Voltage Accuracy	0%- 100% load	--	±1	±3	%	
Linear Regulation	Input voltage variation from low to high at full load	Positive output	--	±0.2	±0.5	
		Negative output	--	±0.5	±1	
Load Regulation ^①	5%- 100% load	Positive output	--	±0.5	±1	
		Negative output	--	±0.5	±1.5	
Ripple & Noise ^②	20MHz bandwidth, 5%- 100% load	--	50	100	mVp-p	
Transient Recovery Time	25% load step change, nominal input voltage	--	300	500	µs	
Transient Response Deviation	25% load step change, nominal input voltage	5V, ±5V output	--	±5	±8	%
		Others	--	±3	±5	
Temperature Coefficient	Full load	--	--	±0.03	%/°C	
Over-voltage Protection	Input voltage range	110	--	160	%Vo	
Over-current Protection	Input voltage range	110	140	--	%Io	
Short-circuit Protection	Input voltage range	Continuous, self-recovery				
Note:						
① When testing under 0% -100% load working conditions, the indicator of load regulation rate is ± 5%;						
② 0% -5% load ripple&noise less than or equal to 5% Vo.						

General Specifications

Item	Operating Conditions	Min.	Typ.	Max.	Unit
Isolation	Input-output Electric Strength Test for 1 minute with a leakage current of 1mA max.	1500	--	--	VDC
Insulation Resistance	Input-output resistance at 500VDC	1000	--	--	MΩ
Isolation Capacitance	Input-output capacitance at 100kHz/0. 1V	--	1000	--	pF
Operating Temperature	See Fig.1	-40	--	+85	°C
Storage Temperature		-55	--	+125	°C
Storage Humidity	Non-condensing	5	--	95	%RH
Pin Soldering Resistance Temperature	Soldering spot is 1.5mm away from case for 10 seconds	--	--	+300	°C
Switching Frequency		--	312.5	--	kHz
MTBF	MIL-HDBK-217F@25°C	1000	--	--	k hours

Mechanical Specifications

Case Material	Aluminum alloy
Package Dimensions	25.4 X 25.40 X 12.00 mm
Weight	11.60g(Typ.)
Cooling Method	Free air convection

EMC Specifications

EMI	CE	CISPR32/EN55032 CLASS B (see Fig.3-② for recommended circuit)				
	RE	CISPR32/EN55032 CLASS B (see Fig.3-② for recommended circuit)				
EMS	ESD	IEC/EN61000-4-2	Contact±4KV	perf.	Criteria	B
	RS	IEC/EN61000-4-3	10V/m	perf.	Criteria	A
	EFT	IEC/EN61000-4-4	±4kV(see Fig.3-①for recommended circuit)	perf.	Criteria	B
	Surge	IEC/EN61000-4-5	line to line±2KV (see Fig.3-①for recommended circuit)	perf.	Criteria	B
	CS	IEC/EN61000-4-6	3Vr.m.s	perf.	Criteria	A

Typical Characteristic Curves

Temperature Derating Curve (Figure 1)

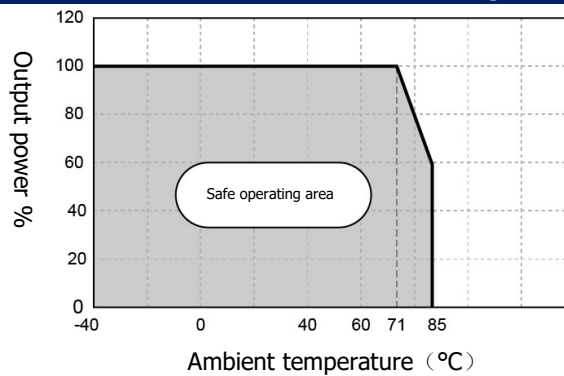

Efficiency Vs Input Voltage (Full Load)

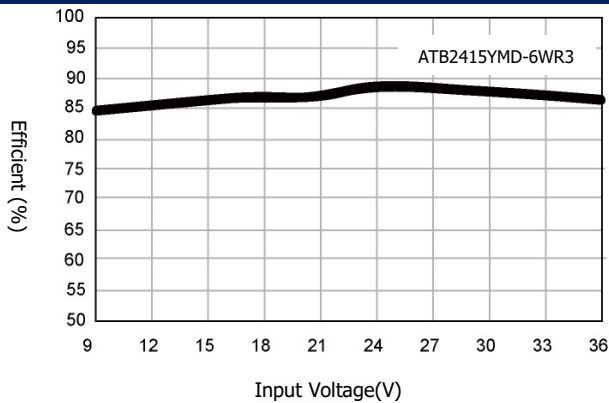

Efficiency Vs Output Voltage (Vin=24V)

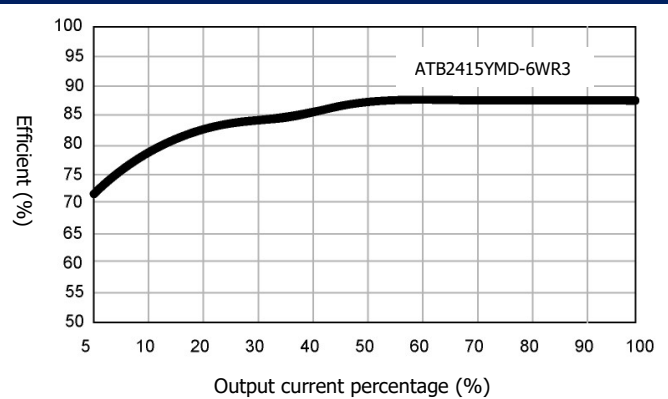

Efficiency Vs Input Voltage (Full Load)

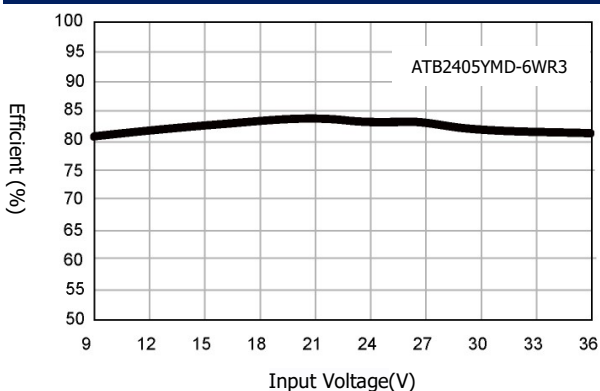

Efficiency Vs Output Voltage (Vin=24V)

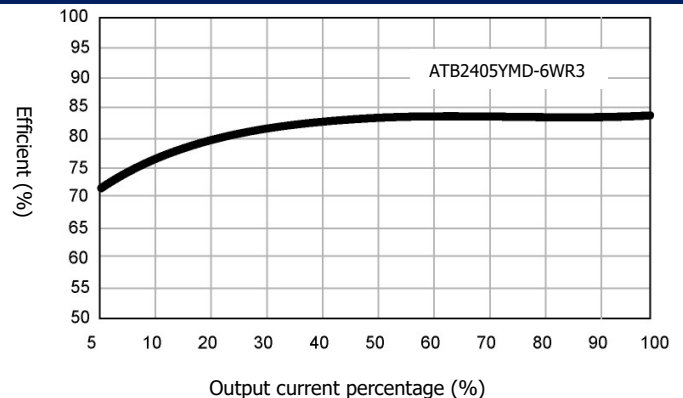

Typical Circuit Design And Application

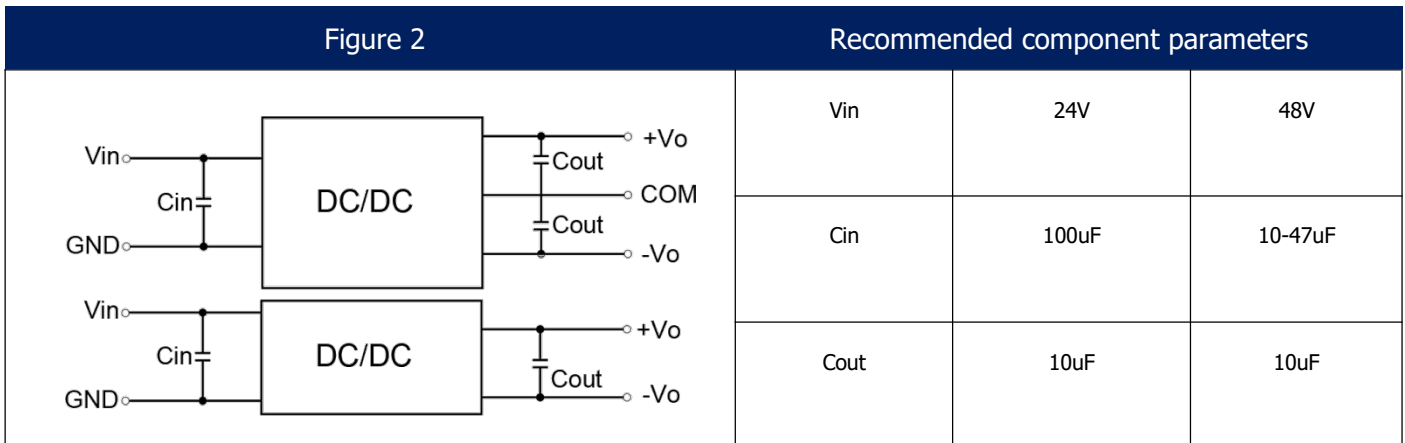

EMC compliance circuit Figure 3

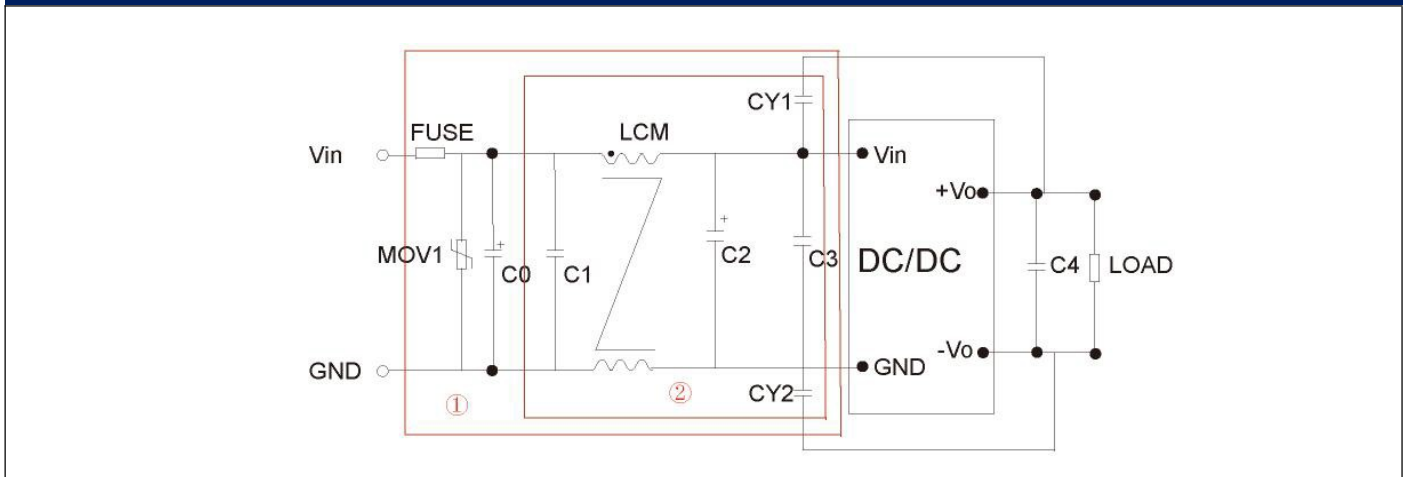

EMI Recommended component parameters

Vin	24V	48V
FUSE	Choose according to actual input current	
MOV	20D470K	14D101K
C0	680uF/50V	680uF/100V
C1	1uF/50V	1uF/100V
C2	330uF/50V	330uF/100V
C3	4.7uF/50V	4.7uF/100V
C4	Refer to the Cout in Fig.2	
LCM	4.7mH	
CY1、CY2	1nF/2KV	

- Note:
- All DC-DC converters of this series are tested before delivery using the recommended circuit shown in Fig.2.
 - Input and/or output ripple can be further reduced by appropriately increasing the input & output capacitor values Cin and Cout and/or by selecting capacitors with a low ESR (equivalent series resistance). Also make sure that the capacitance is not exceeding the specified max. capacitive load value of the product.
 - The products do not support parallel connection of their output.

Dimensions and Recommended Layout

Dimensions

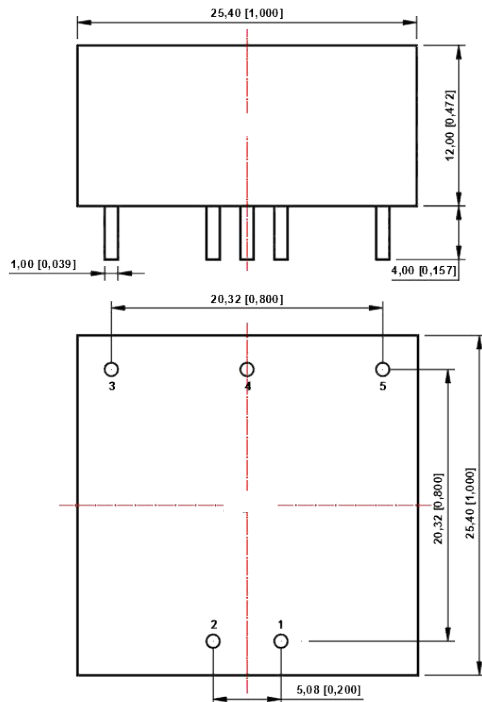

PCB Printing Layout

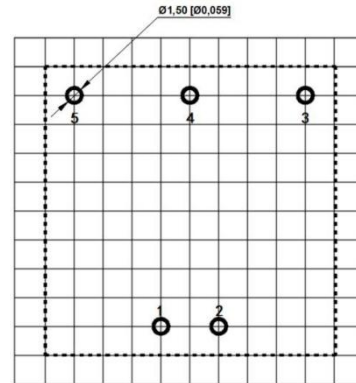

The grid distance is 2.54 x 2.54mm

Pin Definition Table

Pin	Single	Dual
1	GND	GND
2	Vin	Vin
3	+Vo	+Vo
4	No Pin	COM
5	-Vo	-Vo

Note:

- Unit: mm[inch]
- Pin section tolerances: $\pm 0.10 [\pm 0.004]$
- General tolerances: $\pm 0.50 [\pm 0.020]$

Note:

- The input voltage should not exceed the specified range value, otherwise it may cause permanent and irreparable damage;
- It is recommended to use at a load of over 5%. If the load is below 5%, the ripple index of the product may exceed the specifications, but it does not affect the reliability of the product;
- Suggested dual output module load imbalance: $\leq \pm 5\%$. If it exceeds $\pm 5\%$, it cannot be guaranteed that the product performance meets all performance indicators in this manual;
- The maximum capacitive load is tested within the input voltage range and under full load conditions;
- Unless otherwise specified, all indicators in this manual are measured at $T_a=25\text{ }^\circ\text{C}$, humidity $<75\%$ RH, nominal input voltage, and output rated load;
- All indicator testing methods in this manual are based on our company's corporate standards;
- Our company can provide product customization, and specific requirements can be directly contacted by our technical personnel;
- Product specifications are subject to change without prior notice.