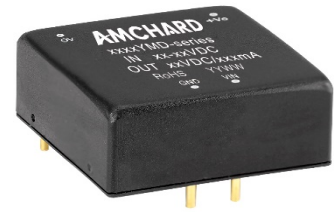

Product Feature

1. Package Type: 1"X 1"
2. Input voltage range: 2:1
3. Operating temperature range: -40°C - +105°C
4. Isolation voltage: 1500VDC
5. High efficiency: 91% (Typ.)
6. The mechanism has input undervoltage protection, Output short circuit protection
7. Fields of application: Power, industrial control, communications, Internet of Things, automotive

3 years Warranty

Selection Guide

Part No.	Input Voltage (VDC)		Output		Full Load Efficiency% (Typ.)	Capacitive Load (µF) Max.
	Nominal (Range)	Max.	Output Voltage (VDC)	Output Current (mA) Max.		
GTB1203YMD-20WR3	12(9-18)	20	3.3	5000/0	84/86	10000
GTB1205YMD-20WR3			5	4000/0	87/89	10000
GTB1212YMD-20WR3			12	1667/0	87/89	1600
GTB1215YMD-20WR3			15	1333/0	88/89	1000
GTB1248YMD-20WR3			48	417/0	88/89	100
GTB2403YMD-20WR3	24 (18-36)	40	3.3	5000/0	86/88	10000
GTB2405YMD-20WR3			5	4000/0	88/90	10000
GTB2412YMD-20WR3			12	1667/0	88/90	1600
GTB2415YMD-20WR3			15	1333/0	89/91	1000
GTB2424YMD-20WR3			24	833/0	89/91	500
GTA2412YMD-20WR3			±12	±833/0	88/90	#800
GTA2415YMD-20WR3			±15	±667/0	88/90	#600
GTA2424YMD-20WR3	±24	±417/0	88/90	#300		
GTB4803YMD-20WR3	48 (36-75)	80	3.3	5000/0	86/88	4700
GTB4805YMD-20WR3			5	4000/0	88/90	2200
GTB4812YMD-20WR3			12	1667/0	89/91	330
GTB4815YMD-20WR3			15	1333/0	89/91	220
GTB4824YMD-20WR3			24	833/0	89/91	500

Input Specifications

Item	Operating Conditions		Min.	Typ.	Max.	Unit
Input Current(full load/no-load)	12VDC nominal input series	3.3VDC Output	--	1599/40	1916/70	mA
		5VDC Output	--	1873/45	1916/70	
		12VDC Output	--	1873/7	1916/20	
		15VDC Output	--	1852/7	1894/20	
		24VDC Output	--	1852/12	1894/20	
	3.3VDC Output	--	782/30	800/50		
		5VDC Output	--	926/35	947/55	

	24VDC nominal input series	12VDC Output	--	926/6	947/15	
		15VDC Output	--	916/6	937/15	
		24VDC Output	--	916/10	937/20	
	48VDC nominal input series	3.3VDC Output	--	391/15	400/30	
		5VDC Output	--	463/20	474/30	
		12VDC Output	--	458/3	469/15	
		15VDC Output	--	458/3	469/15	
		24VDC Output	--	458/4	469/15	
Reflected Ripple Current	Rated input voltage		--	30	--	mA
Impulse Voltage	12VDC nominal input series		-0.7	--	25	VDC
	24VDC nominal input series		-0.7	--	50	
	48VDC nominal input series		-0.7	--	100	
Starting Voltage	12VDC nominal input series		--	--	9	VDC
	24VDC nominal input series		--	--	18	
	48VDC nominal input series		--	--	36	
Input undervoltage protection	12VDC nominal input series		5.5	6.5	--	VDC
	24VDC nominal input series		12	15.5	--	
	48VDC nominal input series		26	30	--	
Ctrl	turn off module		connected GND or (0-1.2V)			
	turn on module		No connected or (3.5-12V)			
	Input current when off		--	2	7	mA
Input Filter	PI filter					

Output Specifications

Item	Operating Conditions	Min.	Typ.	Max.	Unit
Output Voltage Accuracy	5%-100% load	--	±1.0	±3.0	%
Linear Regulation	Vin=Min. to Max. @Full Load	--	±0.2	±0.5	%
Load Regulation	5%-100% load	--	±0.5	±1.0	%
Ripple & Noise	20MHz bandwidth, 5%-100% load	--	50	100	mVp-p
Transient Recovery Time	25% Load Step Change, nominal input voltage	--	300	500	µs
Transient Response Deviation	25% Load Step Change, nominal input voltage	--	±5	±8	%
Temperature Coefficient	Full Load	--	--	±0.03	%/°C
Trim	Rated input voltage	90	--	110	%
Over Voltage Protection	Rated input voltage	110	--	160	%
Over Current Protection	Rated input voltage	110	150	190	%
Short-Circuit Protection	Rated input voltage	Continuous, Self-Recovery			

General Specifications

Item	Operating Conditions	Min.	Typ.	Max.	Unit
Isolation Voltage	I-O, test time 1 minute, leakage current less than 1mA	1500	--	--	VDC
Insulation Resistance	Input-output, insulated voltage 500VDC	1000	--	--	MΩ
Isolation Capacitance	Input-output, 100KHz/0.1V	--	2000	--	pF
Operating Temperature	See Fig 1	-40	--	+105	°C
Storage Temperature		-50	--	+125	°C
Storage Humidity	Non-condensing	--	--	95	%RH

Soldering Profile	1.5mm from case for 10 sec	--	--	300	°C
Switching Frequency	Full load, nominal input voltage	--	300	--	kHz
MTBF	MIL-HDBK-217F@25°C	1000	--	--	K Hours

Mechanical Specifications

Case Material	Aluminum alloy
Package Dimensions	25.4 X 25.40 X 12.00 mm
Weight	21.00g(Typ.)
Cooling Method	Free air convection

EMC Specifications

EMI	CE	EN55032, FCC part 15	CLASS B	
	RE			
EMS	ESD	IEC/EN61000-4-2 Contact±6KV,Air ±8KV	perf.	CriteriaB
	RS	IEC/EN61000-4-3 10V/m	perf.	CriteriaA
	EFT	IEC/EN61000-4-4 ±2KV (Recommended circuit diagram 3-①)	perf.	CriteriaB
	Surge	IEC/EN61000-4-5 line to line±2KV (Recommended circuit diagram 3-①)	perf.	CriteriaB
	CS	IEC/EN61000-4-6 3 Vr.m.s	perf.	CriteriaA

Typical Characteristic Curves

Temperature Derating Curve (Figure 1)

GTB24_YMD-20WR3/GTB48_YMD-20WR3 series
Nominal input voltage, 3.3V, 5V output

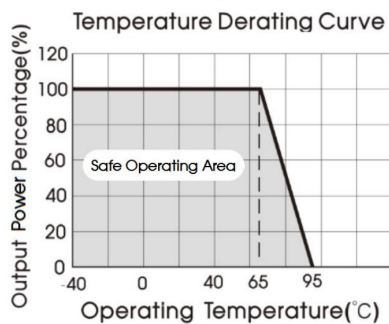

GTB24_YMD-20WR3/GTB48_YMD-20WR3 series
Nominal input voltage, 12V, 15V, 24V output

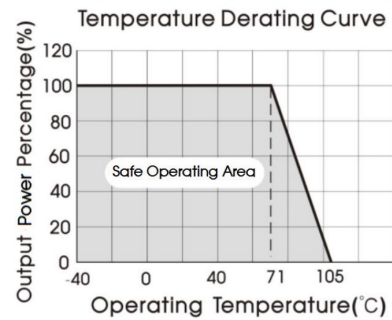

GTB12_YMD-20WR3 series
Nominal input voltage, 3.3V, 5V output

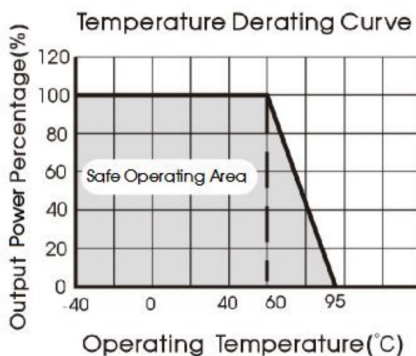

GTB12_YMD-20WR3 series
Nominal input voltage, 12V, 15V, 24V output

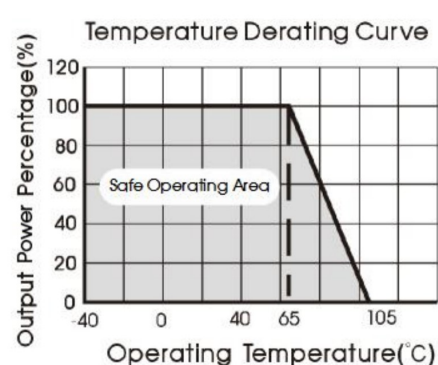

Efficiency Vs Input Voltage (Full Load)

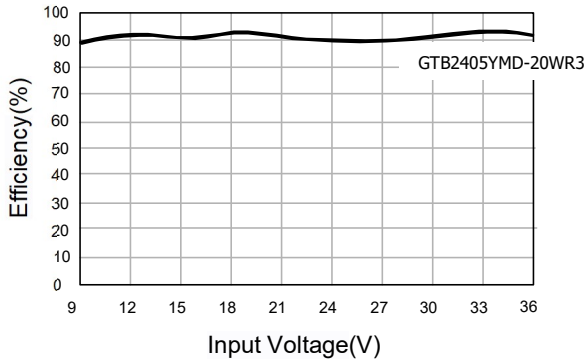

Efficiency Vs Output Voltage (Vin=24V)

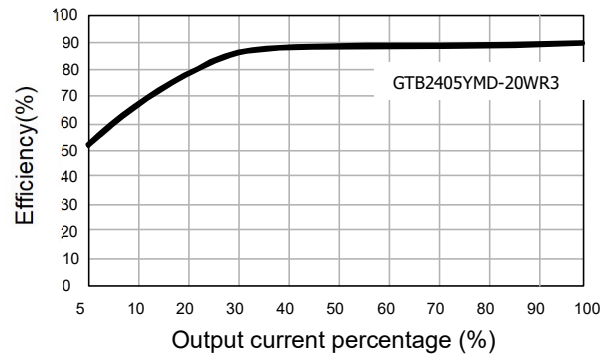

Efficiency Vs Input Voltage (Full Load)

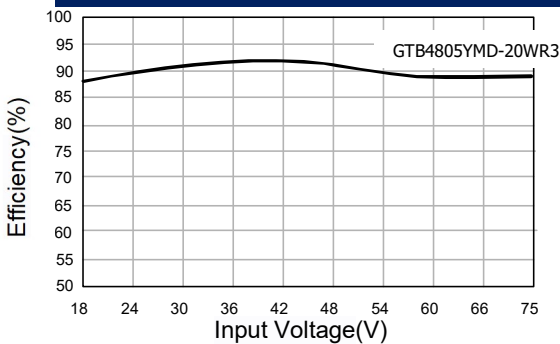

Efficiency Vs Output Voltage (Vin=48V)

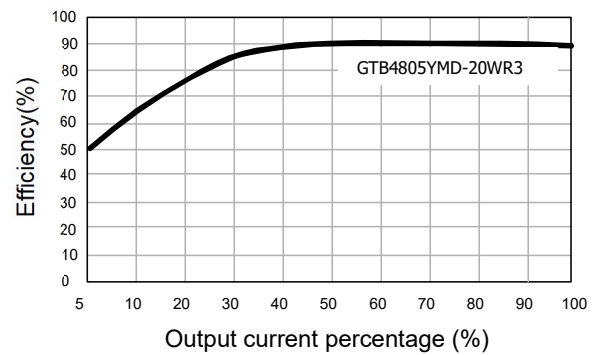

Typical Circuit Design And Application

Figure 2

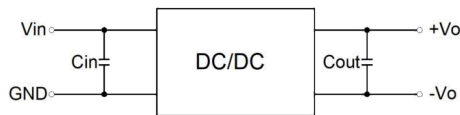

Recommended component parameters

Vin(VDC)	Cin(uF)	Cout(uF)
3.3/5/12/15	100	100
24		47

Figure 3

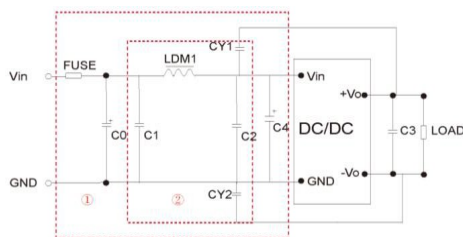

EMI Recommended component parameters

Vin(VDC)	Vin:24V	Vin:48V
FUSE	Choose according to actual input current	
C0、C4	330μF/50V	330μF/100V
C1、C2	4.7μF/50V	4.7μF/100V
C3	Refer to the Cout in Fig.2	
LDM1	2.2uH/4A	2.2uH/2A
CY1/CY2	1nF/2KV	

Figure 4

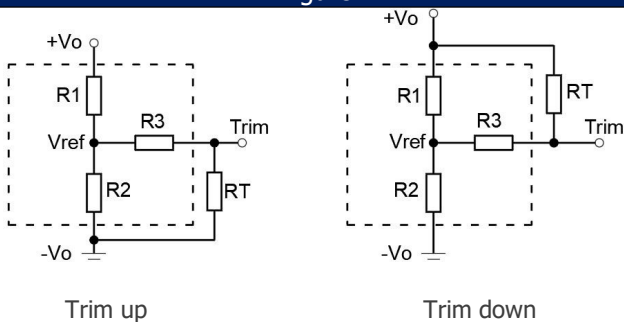

Trim Recommended component parameters

Vout(V)	R1(KΩ)	R2(KΩ)	R3(KΩ)	Vref(V)
3.3	10	6.064	13.622	1.24
5	2.4	2.344	13.622	2.5
12	8.2	2.153	17.346	2.5
15	12	2.388	21.016	2.5
24	10	1.158	10.714	2.5

Trim resistor connections (dashed line shows internal resistor network)

All DC-DC converters of this series are tested before delivery using the recommended circuit shown in Fig. 2. Input and/or output ripple can be further reduced by appropriately increasing the input & output capacitor values C_{in} and C_{out} and/or by selecting capacitors with a low ESR (equivalent series resistance). Also make sure that the capacitance is not exceeding the specified max. capacitive load value of the product.

Dimensions and Recommended Layout

Dimensions

PCB Printing Layout

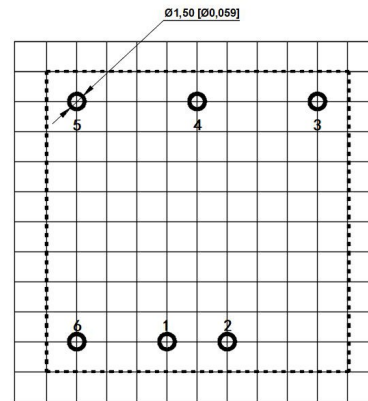
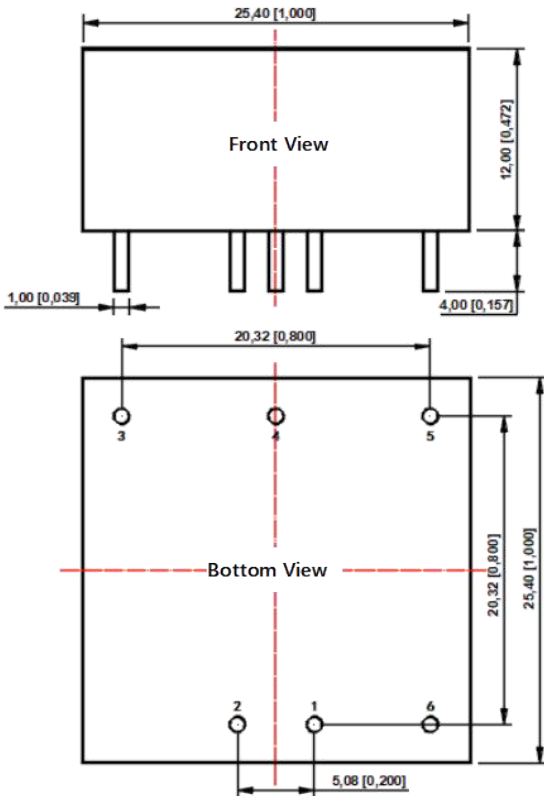

The grid distance is 2.54 x 2.54mm

Note:

- Unit: mm[inch]
- Pin section tolerances: $\pm 0.10 [\pm 0.004]$
- General tolerances: $\pm 0.50 [\pm 0.020]$

Pin Definition Table

Pin	Single	Dual
1	GND	GND
2	Vin	Vin
3	+Vo	+Vo
4	Trim	Com
5	-Vo	-Vo
6	CTRL	CTRL

Note:

1. The input voltage should not exceed the specified range value, otherwise it may cause permanent and irreparable damage;
2. It is recommended to use at a load of over 5%. If the load is below 5%, the ripple index of the product may exceed the specifications, but it does not affect the reliability of the product;
3. Suggested dual output module load imbalance: $\leq \pm 5\%$. If it exceeds $\pm 5\%$, it cannot be guaranteed that the product performance meets all performance indicators in this manual;
4. The maximum capacitive load is tested within the input voltage range and under full load conditions;
5. Unless otherwise specified, all indicators in this manual are measured at $T_a=25^\circ\text{C}$, humidity < 75% RH, nominal input voltage, and output rated load;
6. All indicator testing methods in this manual are based on our company's corporate standards;
7. Our company can provide product customization, and specific requirements can be directly contacted by our technical personnel;
8. Product specifications are subject to change without prior notice.